

New process for brazing ceramics utilizing squeeze casting

KATSUAKI SUGANUMA

*Department of Materials Science and Engineering, National Defence Academy,
Hashirimizu 1-10-20, Yokosuka, Kanagawa 239, Japan*

A new joining process for ceramics to ceramics and ceramics to metals, "SQ brazing", has been developed. This process utilizes squeeze casting; a brazing material is squeezed into the interface channel to be brazed and is solidified under a high pressure. This new process has several advantages, low cost, mass producibility, high interface strength and high reliability, no severe reaction, etc. Alumina to alumina and silicon nitride to silicon nitride brazing with pure aluminium are shown as examples. Alumina containing silica as a sintering additive brazed by a conventional method severely reacted with aluminium braze so that the joint strength was low. After SQ brazing, reaction was moderate and the strength almost reached that of the parent alumina. Silicon nitride could be brazed by SQ brazing. Although the simple SQ brazing could not make a strong interface, pre-oxidization treatment of silicon nitride increased the joint strength beyond 400 MPa.

1. Introduction

Rapid progress in joining technologies for ceramic materials in recent years has enabled us to utilize ceramics for a wide variety of applications, not only for electronic devices but also for structural components and for joining ceramics to metals which is sometimes, one of the key techniques in fabrication. An appropriate method could be selected out of a variety of processes according to the requirements for each application. For instance, the Mo–Mn metallization process has been established and is widely used for joining oxide ceramics in the electronics industry. Active metal brazing and solid-state bonding have been used not only for oxide ceramics but also for non-oxide ceramics such as silicon nitride or silicon carbide in the construction of structural components. These processes could produce strong and reliable joints of ceramics/ceramics and ceramics/metals. Several reviews have been published on the scientific and processing aspects of the processes giving the benefits and faults of each [1–6].

Because joining processes for ceramics are generally batch processes, they are somewhat costly and time consuming. This is not desirable in mass-production systems. Therefore, a new trend in joining has been aimed towards low-cost and short-term processing. Mechanical fastening is, of course, one such process. Shrink-in structure and shrink-in casting are typical. They could give a reliable and heat-resistant joint if a suitable stress analysis, such as the finite element method, is used in the design of its construction. However, mechanical fastening has a limitation because it requires three-dimensional design and it cannot produce a plane-to-plane bonding structure. Furthermore, it is quite difficult to build up a large-scale

joined component by mechanical fastening. Although other processes such as friction welding have their own advantages, they also have some limitations [5, 6]. Thus, it is necessary to establish a new process which is simpler and applicable to more varied requirements.

The aim of the present work, therefore, was to develop a new joining process, i.e. squeeze casting brazing (SQ brazing), which is low cost, mass producible and reliable, utilizing the casting techniques of metallic materials.

2. Principles of SQ brazing

SQ brazing is the process utilizing squeeze casting which has been widely used for casting of metallic materials and metal matrix composites. The squeeze casting is a casting process in which a metallic melt is solidified in a mould under a high pressure of 10–100 MPa. Fig. 1 shows the schematic concept of the SQ brazing process. First, the constituents to be brazed are set in a mould. The mould and the constituents are preheated to a certain temperature and a braze alloy, melted in a crucible, is poured into the mould. Subsequently, high pressure is applied to the melt surface. The braze is solidified within a minute under a high pressure. The brazed component is then removed from the mould and cooled.

Because infiltration and solidification of the braze material proceed under a high pressure, SQ brazing has several advantages.

1. Low cost: this process does not require a large-scale vacuum furnace, which is required for active metal brazing and for solid-state bonding.

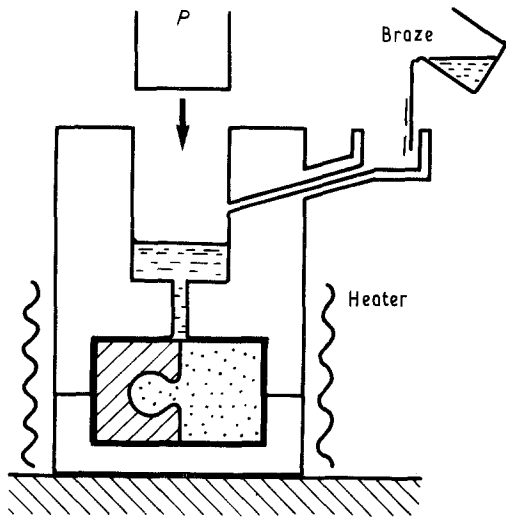

Figure 1 Schematic drawing of the SQ brazing.

2. Mass producibility: brazing treatment can be finished within a few minutes if suitable preheating and cooling furnaces are supplied.

3. No-oxidation problem: because brazing proceeds under a dynamic liquid metal flow, the surface oxide layer is effectively removed even when brazing in an oxidizing environment. Therefore, an active metal can be used as a braze material even in an air atmosphere.

4. Large/complex shape face brazing: brazing metal can infiltrate into curved and complex channels. It is possible to braze curved faces, as schematically shown in Fig. 1.

5. No severe reaction: because brazing treatment ceases within a very short time, the reaction at the interface is not very severe, which sometimes becomes a problem in active metal brazing.

6. Controlled thickness of the braze layer: the thickness of the braze layer is determined only by the fixing conditions of the constituents to be brazed. It is easy to produce a certain thickness of braze.

7. Elimination of defects on the interface: high-pressure solidification of a braze can eliminate defects at the interface such as an unbonded area formed in a non-wetting system.

Thus this new process has many advantages which no conventional bonding method has, and there is only one area in which care must be taken in performing the SQ brazing of ceramics. Because ceramics are susceptible to sudden temperature changes, they must be protected from thermal shocks during brazing. The difference between the preheating temperature of the ceramics and that of the brazing alloy must be smaller than the critical temperature of thermal shock.

The casting pressure must be above a certain critical value at which infiltration of a molten braze into a narrow interfacial channel to be brazed occurs. The critical pressure can be obtained by two elemental calculations using the surface tension/capillary pressure relation and the pressure drop by melt passage. Fig. 2 shows a schematic model of liquid flow through

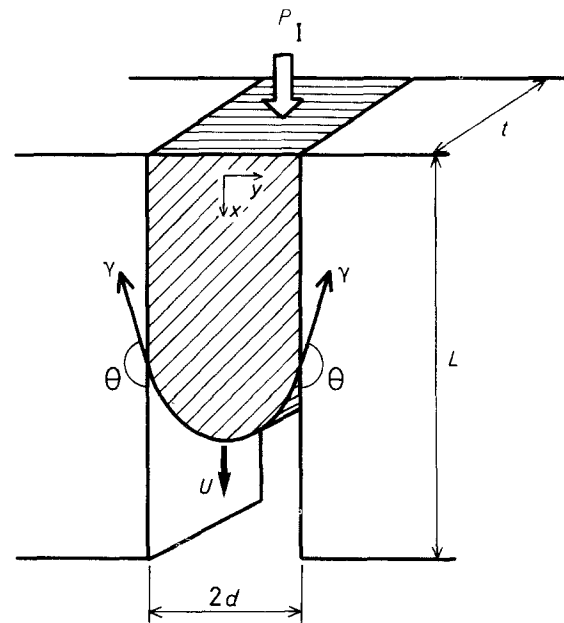

Figure 2 Schematic model of liquid flow through a narrow channel.

a narrow channel sandwiched between two walls, which are a distance $2d$ apart. The pressure drop across the melt/atmosphere interface is ΔP_T . The front of the melt has some curvature and the contact angle between a wall and a melt is θ . If the liquid is at rest when all external forces are balanced, i.e. the pressure difference across the liquid front and the surface tension

$$P_T 2dt = 2\gamma \cos \theta t \quad (1)$$

where t is the depth of the channel. Then

$$\Delta P_T = \gamma \cos \theta / d \quad (2)$$

Equation 2 gives the critical pressure for infiltration through a narrow channel restricted by the surface tension of the braze. The following example of this calculation is for the ceramics/aluminium system, which was used in the present experiment, as shown in a later section. At 1083 K, which was the brazing temperature in the present work, surface tension force of the aluminium melt is 865 dyn cm^{-1} [7]. Fig. 3 shows the critical pressure change as a function of contact angle for various braze layer thicknesses. Below $\theta = 90^\circ$, infiltration takes place without any applied force. Above 90° , the critical pressure increases with increasing contact angle and decreasing channel thickness. Unfortunately, reliable data for contact angles between ceramics and aluminium are lacking because of the protective surface oxidation film of the aluminium melt. In the joining system in which $\theta = 150^\circ$, which is for a non-wetting system and is the experimentally determined value for the silicon nitride/aluminium system [8], brazing with a $1 \mu\text{m}$ braze layer thickness requires a critical applied pressure of $\sim 1.5 \text{ MPa}$.

Once a pressure difference sufficient to generate melt flow has been developed across the melt/atmosphere interface, the only force opposing passage of the melt through the channel arises from viscous resistance to flow. This will determine the relationship

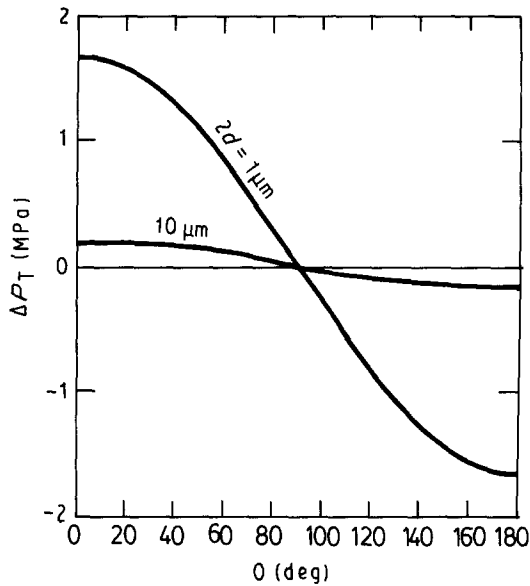

Figure 3 Pressure drop due to surface tension of a liquid as a function of contact angle between the liquid and the channel wall, and the influence of channel width.

between the flow velocity and the pressure gradient in the melt. The formula for the local liquid velocity, u , as a function of distance from the centre of the channel, i.e. y in Fig. 2, is derived from the Navier-Stokes equation

$$u = (\alpha/2\mu)(d^2 - y^2) \quad (3)$$

where α is the pressure gradient in the melt ($= \partial P/\partial x$) and μ is the viscosity of a melt. The total amount of melt flow across the channel in a unit depth, U , is given by integration of Equation 3 from $y = -d$ to d .

$$U = 2 \int_0^d u \, dy = 2 \int_0^d (\alpha/2\mu)(d^2 - y^2) \, dy \\ = 2\alpha d^3/3\mu \quad (4)$$

In Equation 4, $\alpha = \Delta P_v/L$, where ΔP_v is the pressure drop across the channel distance L . Finally, Equation 4 gives

$$\Delta P_v = 3\mu L U/2d^3 \quad (5)$$

Equation 5 gives the pressure drop across the whole channel distance L and ΔP_v becomes the critical pressure for the infiltration opposing viscous flow. This pressure varies as functions of the channel distance and flow speed. With increasing flow speed or decreasing channel distance, the critical pressure increases rapidly. Fig. 4 shows the critical pressure as a function of thickness of the braze layer for various flow speeds, in which the viscosity of the aluminium melt at 1083 K is 0.025 P [7] and flow distance is 15 mm which is the joint size in the present work. When the thickness of the braze layer is more than 10 μm , the critical pressure is very low. Below this thickness, the pressure increases drastically. If it is intended to make 10 μm thick braze layer, a pressure of 45 MPa under a flow speed of $10^{-5} \text{ m}^3 \text{ s}^{-1}$ is required, which is a reasonable speed for squeeze casting. In our experiment, the flow speed of the aluminium melt was limited by the machine conditions used and was around $1.94 \times 10^{-5} \text{ m}^3 \text{ s}^{-1}$.

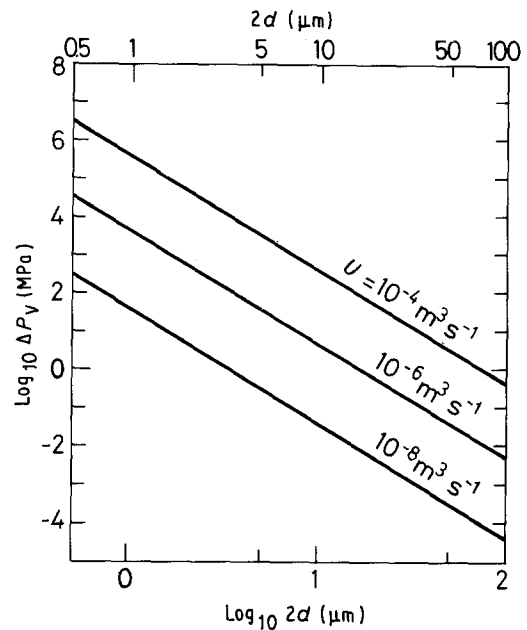

Figure 4 Pressure drop due to viscosity of a liquid as a function of channel width, and the influence of flow speed.

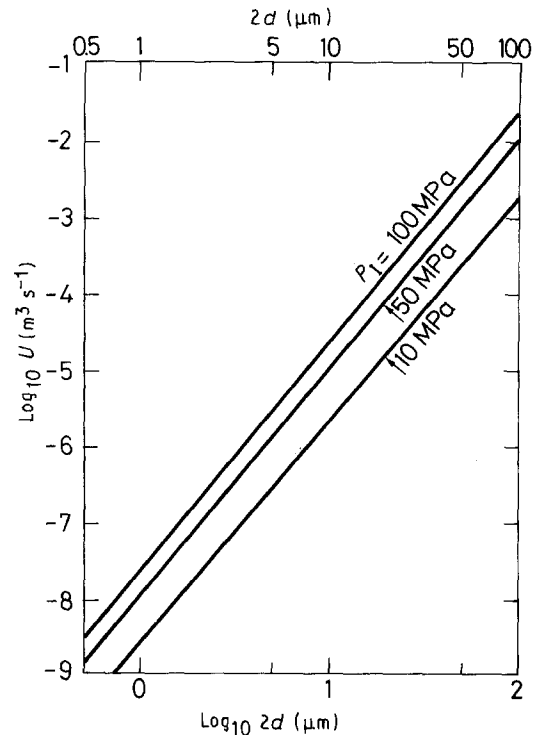

Figure 5 Flow velocity as a function of channel width, and the influence of infiltration pressure.

The total critical pressure for infiltration, P_1 , is given by the sum of Equations 2 and 5. The flow speed is determined from the relationship between the infiltration pressure and the braze layer thickness, and is expressed as

$$U = (2d^2/2\mu L)(P_1 d - \gamma \cos \theta) \quad (6)$$

Equation 6 gives the flow speed under a certain brazing condition. Fig. 5 shows the flow speed as a function of channel thickness. The channel thickness, 10 μm , and the infiltration pressure, 50 MPa, which seem to be realistic values, give a flow speed of $10^{-5} \text{ m}^3 \text{ s}^{-1}$.

3. Experimental procedure

3.1. Materials

In the present work, ceramics were brazed to themselves using a pure aluminium braze. Two kinds of ceramics were used. One was a pressureless sintered alumina containing 7 wt % silica as a sintering additive. The average bending strength of the alumina was 350 MPa. The other ceramic was a pressureless sintered silicon nitride (E0010), with an average bending strength of 900 MPa. The blocks of silicon nitride were 15 mm × 10 mm bonding face and 10 mm long. To promote wetting of the aluminium melt, some of the silicon nitride was pre-heat-treated at 1123 K for 1 h to enhance the bonding to the aluminium melt due to the presence of a silica layer formed by oxidation [9, 10]. The aluminium used as braze material was JIS 1050 (99.5 wt % pure aluminium).

3.2. SQ brazing

SQ brazing was carried out in an air atmosphere. The temperatures of the alumina, the aluminium melt and the mould were 1073, 1073 and 873 K, respectively. In SQ-brazing of silicon nitride, the temperature of the silicon nitride was 873 K. This temperature is 200 K below that of the aluminium melt and, therefore, silicon nitride is exposed to a certain heat shock, but this temperature difference is much smaller than the critical temperature of heat shock, i.e. 400 K. The casting pressure was 50 MPa and was maintained for 5 min.

In the case of brazing alumina, two blocks, of dimensions 15 mm square face to be brazed and length 20 mm, were faced together and fixed in a mould. Two types of joint were fabricated. One sample was closely contacted and tightly fixed and the other was loosely contacted. As a result, the former joints had a narrow brazing layer (about 10 μm thick) and the latter had a somewhat thicker braze layer (about 300 μm thick). In the case of silicon nitride brazing, the thickness of the braze layer was 200 μm thick.

As a comparison, conventional brazing was also carried out using the same alumina and aluminium braze. Two blocks of alumina were placed in a furnace and centred on an aluminium braze sheet, 200 μm thick. The applied brazing pressure was 0.01 MPa. The temperature, 1073 K, was the same as in the SQ brazing and was held for 10 min. Two kinds of brazing atmosphere were examined, air and argon.

3.3. Evaluations

Microscopic observation of the brazed interface was carried out to determine the reaction and defect distribution at the interface by optical microscopy (OM) and electron microprobe analysis (EPMA). Three-point bending tests were performed at room temperature to evaluate the strength of the interfaces. Bending specimens were cut from brazed samples into bars 3 mm × 3 mm × 40 mm for the alumina joint and 3 mm × 3 mm × 30 mm for the silicon nitride joint. The spans were 30 mm for the alumina joint and 25 mm for the silicon nitride joint. The crosshead

speed was 0.5 mm min⁻¹. The strength data shown below are average values of at least four specimens.

4. Results and discussion

4.1. SQ brazing of alumina

Table I summarizes strength data of the brazed alumina. Although conventional brazing in an argon gas flow could produce a joint, its strength was very low. In an air atmosphere, no joint was obtained because of oxidation of the aluminium braze. A protective surface oxide layer on the braze prevented the formation of an interfacial reaction and bonding between alumina and the aluminium braze. Previous work on silicon nitride brazing with aluminium also reported similar results with brazing atmosphere [7]. Silicon nitride could not be brazed in air by the conventional brazing process with aluminium. This is one of the limits of active brazing.

On the contrary, the SQ brazed joint exhibited a quite high strength. In particular, a thin braze layer could almost produce a strength level of the parent alumina, which was 350 MPa. Fig. 6 shows a Weibull plot of bending strength of the SQ brazed joint with a 300 μm thick braze layer. The scatter in strength was small and a good Weibull modulus was achieved.

Fig. 7 compares the interfacial microstructures of the conventionally brazed and SQ brazed joints observed by polarized optical microscopy. In the

TABLE I Summary of bending strength of alumina joints

Brazing method	Atmosphere	Thickness of braze layer (μm)	Strength (MPa)
Conventional	Air	—	0
	Argon flow	10	49
SQ brazing	Air	10	325
		300	228

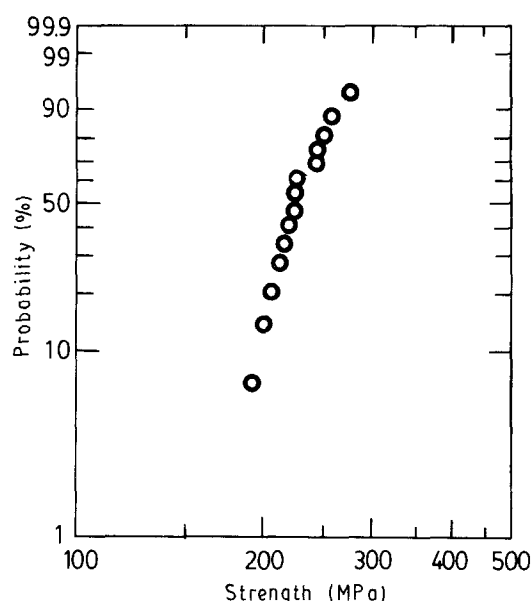

Figure 6 Weibull plot of bending strength of the SQ brazed alumina. The braze layer thickness is 300 μm. $\sigma = 228$ MPa, $m = 10.4$.

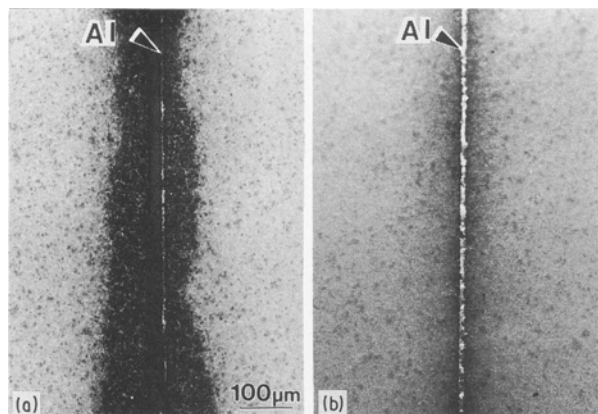

Figure 7 Microstructures of the interfaces of the brazed alumina (OM). (a) Conventional brazing, (b) SQ brazing.

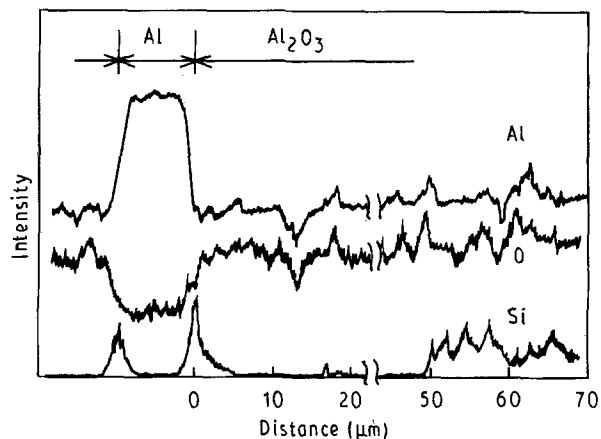

Figure 8 EPMA line analysis of the interfacial region of the alumina brazed by the conventional method.

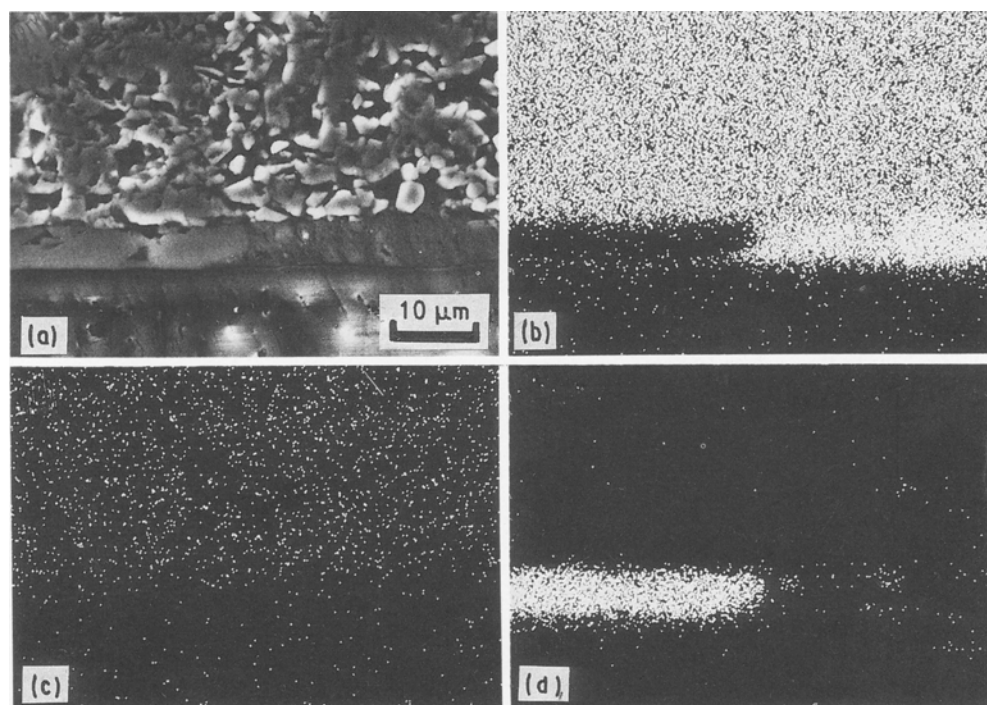
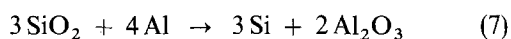

Figure 9 (a) Scanning electron micrograph and (b-d) EPMA areal analysis of the interfacial region of alumina brazed by the conventional method: (b) Al, (c) O, (d) Si.

conventional brazing, although the brazing period was very short, 10 min, a wide reaction layer, which is recognized as the dark contrast area along the interface, was formed deep into the alumina. The thickness of the reaction layer ranged from about 20–100 μm . The EPMA line analysis across the interface of this joint is shown in Fig. 8. This reaction layer formed in alumina was a depleted zone of silicon which had been contained as the sintering binder, silica, of the parent alumina.

Silica is easily reduced to silicon by molten aluminium at elevated temperature



The free energy change of this reaction at 1083 K is about -400 kJ mol^{-1} [7]. In the present case, silicon was enriched around the interface. Fig. 9 shows a scanning electron micrograph and the EPMA areal

analysis near the braze layer. Silicon does not exist continuously along the interface but sometimes formed precipitates in the braze layer, which are thought to be pure silicon crystals, from the Al–Si phase diagram [11]. In addition the alumina near the interface had a very porous structure which was caused by the depletion reaction of sintering binder during brazing. Both the porous structure in the alumina along the interface and the large brittle silicon crystals in the braze layer seem to be the origin of the severe decrease in joint strength compared with the parent body.

On the contrary, the SQ brazed joint did not show any severe reaction, as seen in Fig. 6. Fig. 10 shows a scanning electron micrograph of the SQ brazed interface. The interface was defect free and no porous structure in the alumina and no precipitates of silicon in the braze layer were observed. Fig. 11 shows the line

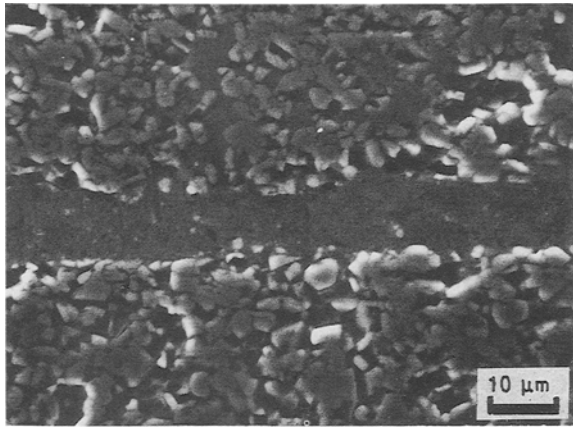

Figure 10 Scanning electron micrograph of the interfacial region of the SQ brazed alumina.

analysis across the interface; little diffusion of silicon from alumina into the interface and to the braze layer can be seen. Such a clean interfacial structure seems to be of benefit in making a strong joint. Thus, it is concluded that the SQ brazing effectively prevents the severe reaction which occurs in brazing of alumina with silica binder, and made the joint strong and reliable.

4.2. SQ brazing of silicon nitride

Silicon nitride can be brazed with aluminium in inert gas flows such as argon, nitrogen, and in vacuum [12]. The reaction between silicon nitride and aluminium is known to be very moderate, different from the alumina-silica/aluminium system. The reaction layer thickness formed under conventional brazing does not exceed 1 μm at 1083 K, even for a long brazing period. The joint strength is above 400 MPa if the braze layer is thin, about a few micrometres [12]. Table II summarizes the strength of the SQ brazed joints with aluminium brazed under the same conditions as in brazing the alumina-silica.

The strength of the SQ brazed joint without any pre-heat treatment of silicon nitride was low compared with the parent body. Microstructural observation with OM, SEM and EPMA revealed the occurrence of no severe reaction at the interface, which is consistent with the previous work [12]. All specimens fractured along the interface. Thus, the simple SQ brazing of silicon nitride only produces a weak bonding at the silicon nitride/aluminium interface. Of course, brazing conditions, such as temperature, may influence the bonding quality. Increasing the temperature of the aluminium melt or of the silicon nitride is expected to enhance bond formation at the interface. In the present work, however, a simple pre-heat-treatment of silicon nitride was carried out. The oxidation treatment of silicon nitride has been reported to enhance bonding between silicon nitride and aluminium [9, 10]. Table II also shows the strength data of the SQ brazed joint of the pre-heat-treated silicon nitride. The thickness of the aluminium braze layer was about 200 μm. Again, the interface also showed

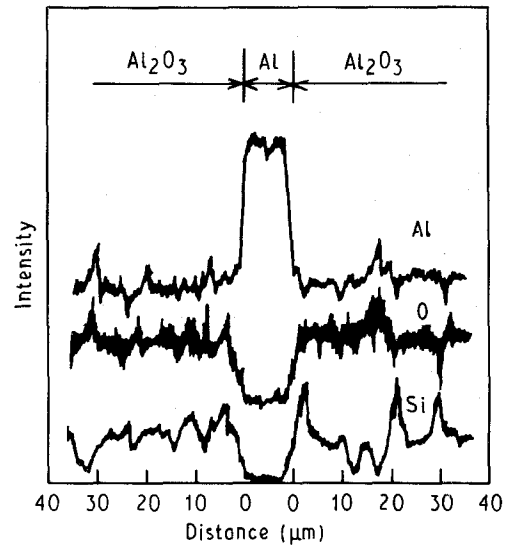

Figure 11 EPMA line analysis of the interfacial region of the alumina brazed by the SQ brazing method.

TABLE II Summary of bending strength of silicon nitride joints brazed by the SQ method

	Bending strength (MPa)
As-received Si ₃ N ₄	57
Pre-oxidation treated Si ₃ N ₄	404

little reaction. The strength, however, increased drastically and reached 400 MPa. All joints fractured completely inside the braze layer and, therefore, the interfacial bonding is stronger than 400 MPa. Thus, simple pre-oxidation treatment of silicon nitride can produce a strong joint by the SQ brazing.

5. Conclusions

A new brazing process, "SQ brazing", of ceramics is outlined. The main advantages of this process are the low production cost and the high reliability/strength of the interface obtained. Severe reaction, which sometimes limits adoption of the active metal brazing for certain kinds of ceramics, for instance not only alumina-silica but also zirconia, diamond, PZT, etc., is not a serious problem in the SQ brazing. Non-active combinations such as silicon nitride/aluminium could be tightly brazed by this process with a simple surface activation treatment.

The simple calculation for the melt infiltration in the SQ brazing gave a guide to the critical pressure required for brazing. In the present case the melt flow was assumed to be laminar. However, if the melt flow is turbulent, it will effectively break the surface oxidation film and might cleanse the surface of ceramics by the jet formed preceding the moving melt front of a braze, as in the case of the explosion bonding process. Thus the squeeze cast speed, which is determined by the relation between the ram speed and the braze layer thickness, will have a certain influence on the quality of the SQ brazed interface.

Examples shown here were limited to aluminium brazing. However, other brazing materials such as copper alloys, silver-copper alloys, nickel alloys, gold alloy with active metals such as titanium, which have higher melting points than aluminium, could be used as brazing materials under a certain condition control. Oxidation of active metals can be prevented only by adoption of an inert atmosphere in molten brazing materials. The SQ brazing itself can be performed in an air atmosphere because the exposure of the active brazing materials to an oxidative atmosphere is limited to a very short period. In addition, glass-ceramics can also be used as brazing materials in the present process, if a sufficiently low viscosity and high pressure are established. Thus, it is concluded that SQ brazing has great potential for brazing ceramics for a wide variety of applications.

Acknowledgements

The author thanks Professor T. Fujita, NDA, and Professor K. Niihara, ISIR, Osaka University, for their continuous encouragement, and also Mr

S. Takenishi, Kyocera Corporation, for supplying silicon nitride ceramics.

References

1. R. W. RICE, in "Advances in Joining Technology", edited by J. J. Burke, A. E. Gorum and A. Tarpinian (Brook Hill, Chestnut Hill, Boston, MA, 1976) pp. 69-111.
2. M. G. NICHOLAS and D. A. MORTIMER, *Mater. Sci. Technol.* **1** (1985) 657.
3. J. A. PASK, *Amer. Ceram. Bull.* **66** (1987) 1587.
4. R. E. LOEHMAN, *Amer. Ceram. Bull.* **68** (1989) 891.
5. K. SUGANUMA, Y. MIYAMOTO and M. KOIZUMI, *Ann. Rev. Mater. Sci.* **18** (1988) 47.
6. K. SUGANUMA, *ISIJ Int.* **30** (1990) 1046.
7. "Handbook of Advanced Aluminum Technology" (Light Metal, Tokyo, 1985) (in Japanese).
8. M. G. NICHOLAS, D. A. MORTIMER, L. M. JONES and R. M. CRISPIN, *J. Mater. Sci.* **25** (1990) 2679.
9. M. MORITA, K. SUGANUMA and T. OKAMOTO, *J. Mater. Sci. Lett.* **6** (1987) 474.
10. *Idem*, *J. Adhes. Sci. Technol.* **2** (1988) 43.
11. M. HANSEN and K. ANDERKO (eds), "Constitution of Binary Alloys", 2nd Edn (McGraw-Hill, New York, 1986).
12. K. SUGANUMA, T. OKAMOTO, M. KOIZUMI and M. SHIMADA, *J. Mater. Sci.* **22** (1987) 1359.

*Received 3 September 1990
and accepted 28 February 1991*